

**DESCRIPTION**

The A307 is a step-down switching regulator with all the required active functions, capable of driving 2A load with good line and load regulations. The device is available in fixed output voltages of 3.3V, 5V, and an adjustable output version. It offers a high-efficiency replacement for popular three-terminal linear regulators and requires only a minimum number of external components.

The  $\pm 2\%$  tolerance on output voltage within specified input voltages and output load conditions is guaranteed. External shutdown is included, featuring 70 $\mu$ A (typical) standby current. The output switch includes cycle-by-cycle current limitation, as well as thermal shutdown for full protection under fault conditions.

A307 can also be used as a Buck type power LED driver. It allows high brightness power LED operating at high efficiency from 7V<sub>DC</sub> to 40V<sub>DC</sub>.

**FEATURES**

- **Wide input voltage range, up to 40V.**
- **Internal oscillator of 150 KHz fixed frequency.**
- **Wide adjustable version output voltage range, from 1.23V to 37V  $\pm 4\%$  max over line and load conditions.**
- **Low standby current, typ. 70 $\mu$ A, at shutdown mode.**
- **Minimum external components.**
- **Thermal shut down and current limit protection.**
- **Can be used for LED driver.**

**APPLICATIONS**

- LCD Monitors
- ADD-ON Cards Switching Regulators
- High Efficiency Step-Down Regulators
- Efficient Pre-regulator for Linear Regulators
- Power LED Driver, MR16
- Automotive Lighting

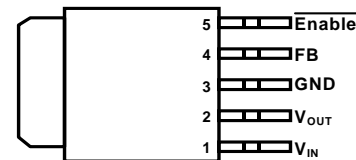
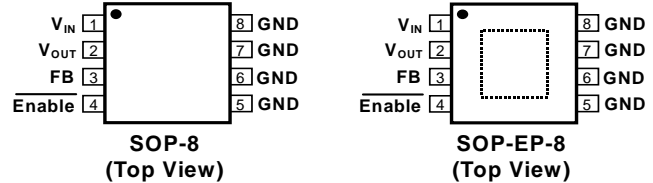
**PACKAGE PIN OUT**

**A307-ADJ  
TO-252 (Top View)**
**VOLTAGE OPTIONS**

- A307xFT-3.3 – 3.3V Fixed
- A307xFT-5.0 – 5.0V Fixed
- A307xFT-ADJ – Adjustable Output

**ORDER INFORMATION**

Temperature Range	<b>D</b>	Plastic SOP 8 Pin	<b>E</b>	Plastic SOP-EP 8 Pin	<b>S</b>	TO-252 5 Pin
-40°C ≤ T <sub>A</sub> ≤ 125°C		<b>A307DFT-X.X</b>		<b>A307EFT-X.X</b>		<b>A307SFT-X.X</b>
		<b>A307DFT-ADJ</b>		<b>A307EFT-ADJ</b>		<b>A307SFT-ADJ</b>

Note:

 Part Number: **A 3 0 7** □ □ □ - □ □ □

Package Type ←

Voltage Options

The letter "T" is marked for Tape &amp; Reel.

The letter "F" is marked for Lead Free.

**TYPICAL APPLICATIONS**

Figure 1. Fixed Output Voltage Versions



$$V_{OUT} = V_{REF} \left( 1 + \frac{R2}{R1} \right)$$

$$R2 = R1 \left( \frac{V_{OUT}}{V_{REF}} - 1 \right) \quad \text{Where } V_{REF} = 1.23V, R1 \text{ between } 1K \text{ and } 5K$$

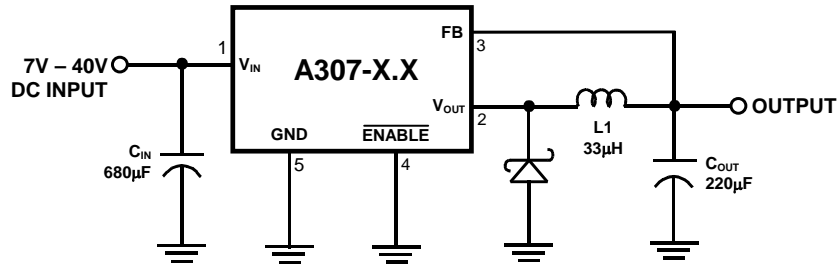
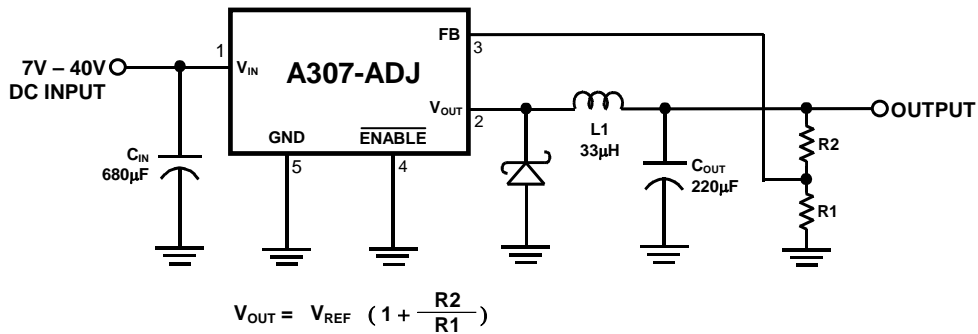
Figure 2. Adjustable Output Voltage Versions

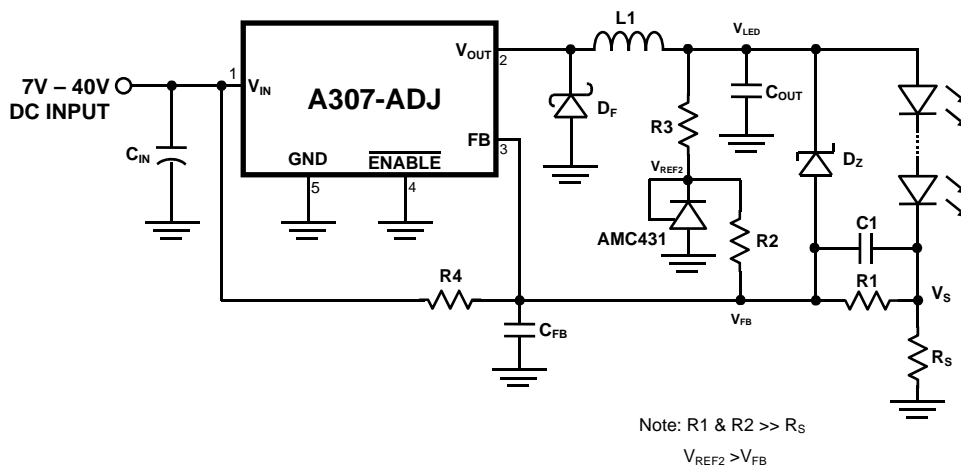

Figure 3. 1W Power LED Driver

**ABSOLUTE MAXIMUM RATINGS (Note 1)**

Input Voltage, $V_{IN}$	45V
ENABLE Pin Input Voltage	$-0.3V \leq V \leq V_{IN}$
Operating Junction Temperature, $T_J$	150°C
Storage Temperature Range	-65°C to 150°C
Lead Temperature (soldering, 10 seconds)	260°C

Note 1: Exceeding these ratings could cause damage to the device. All voltages are with respect to Ground. Currents are positive into, negative out of the specified terminal.

**RECOMMENDED OPERATING RATINGS**

Temperature Range	$-40^\circ C \leq T_A \leq 125^\circ C$
Input Voltage, $V_{IN}$	40V(Max.)

**THERMAL DATA**

Package Type	Thermal Resistance-Junction to Ambient, $\theta_{JA}$
SOP-8	160 °C /W
SOP-EP-8	96 °C /W
TO-252	80 °C /W

Junction Temperature Calculation:  $T_J = T_A + (P_D \times \theta_{JA})$ .

The  $\theta_{JA}$  numbers are guidelines for the thermal performance of the device/pc-board system.

All of the above assume no ambient airflow.

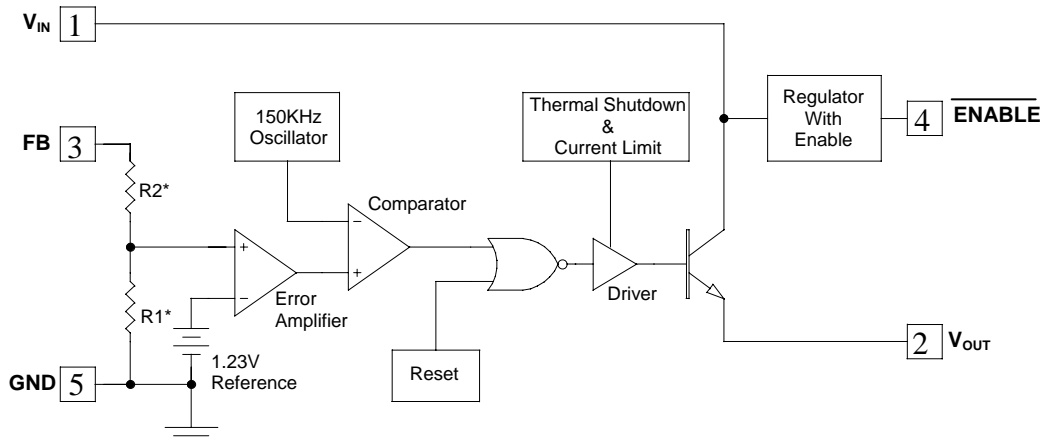
**BLOCK DIAGRAM**

$$\begin{aligned}
 V_{OUT} = 3.3V & : R2/R1 = 1.7 \\
 V_{OUT} = 5.0V & : R2/R1 = 3.1 \\
 V_{OUT} = \text{Adjustable} & : R2 = 0 \\
 & R1 = \text{Open}
 \end{aligned}$$

**DC ELECTRICAL CHARACTERISTICS**

 Unless otherwise specified,  $V_{IN} = 12V$ ,  $I_{LOAD} = 0.5A$  and the operating ambient temperatures  $T_A = 25^\circ C$ .

Parameter		Symbol	Test Conditions		A307			Unit
					Min	Typ	Max	
Output Voltage (Note 1)	A307-3.3	$V_{OUT}$	Test circuit of Figure 1		3.234	3.300	3.366	V
	A307-5.0				4.900	5.000	5.100	
	A307-3.3		$0.2A \leq I_{LOAD} \leq 1A$	$6V \leq V_{IN} \leq 40V$	3.168	3.300	3.432	V
	A307-5.0		Test circuit of Figure 1	$8V \leq V_{IN} \leq 40V$	4.800	5.000	5.200	
	A307-3.3		$0.2A \leq I_{LOAD} \leq 1A$ , $-40^\circ C \leq T_A \leq 125^\circ C$	$6V \leq V_{IN} \leq 40V$	3.135	3.300	3.482	V
	A307-5.0		Test circuit of Figure 1	$8V \leq V_{IN} \leq 40V$	4.750	5.000	5.250	
Feedback Voltage (Note 1)	A307-ADJ	$V_{OUTFB}$	Test circuit of Figure 2	$V_{OUT} = 5V$	1.217	1.230	1.243	V
	A307-ADJ		$8V \leq V_{IN} \leq 40V$ , $V_{OUT} = 5V$ , Test circuit of Figure 2	$0.2A \leq I_{LOAD} \leq 1A$	1.193	1.230	1.267	V
	A307-ADJ		$8V \leq V_{IN} \leq 40V$ , $V_{OUT} = 5V$ , Test circuit of Figure 2	$0.2A \leq I_{LOAD} \leq 1A$ , $-40^\circ C \leq T_A \leq 125^\circ C$	1.180	1.230	1.286	V
Efficiency	A307-3.3		$I_{LOAD} = 1A$			75		%
	A307-5.0					77		
	A307-ADJ		$I_{LOAD} = 1A, V_{OUT} = 5V$			77		
Oscillator Frequency	$f_{OSC}$	(Note 2)	$T_A = 25^\circ C$	130	150	170	kHz	
			$-40^\circ C \leq T_A \leq 125^\circ C$		150			
Quiescent Current	$I_Q$	(Note 3)			5	10	mA	
Standby Current	$I_{STBY}$		$\overline{ENABLE} = 5V$			50	200	$\mu A$
Saturation Voltage	$V_{SAT}$	$I_{LOAD} = 1A$ (Note 4)	$T_A = 25^\circ C$		1.4	1.8	V	
			$-40^\circ C \leq T_A \leq 125^\circ C$			2.0		
Feedback Bias Current	$I_{FB}$	$V_{OUT} = 5V$ (ADJ version only)	$T_A = 25^\circ C$		50	100	nA	
			$-40^\circ C \leq T_A \leq 125^\circ C$			500		
Duty Cycle (ON)	DC	(Note 5)		93	98		%	
Current Limit	$I_{LIMIT}$	(Note 2, 4)	$T_A = 25^\circ C$	2.2	3	3.8	A	
			$-40^\circ C \leq T_A \leq 125^\circ C$	2.2		4		
Output Leakage Current	$I_{LEAK}$	(Note 3)	$V_{OUT} = 0V$		0.3	2	mA	
			$V_{OUT} = -1V$		9	30		
ENABLE Threshold Voltage	$V_{IH}$	$V_{OUT} = 0V$	$T_A = 25^\circ C$	2.2	1.4		V	
			$-40^\circ C \leq T_A \leq 125^\circ C$	2.4				
	$V_{IL}$	$V_{OUT} = \text{Normal Output Voltage}$	$T_A = 25^\circ C$		1.2	1.0		
			$-40^\circ C \leq T_A \leq 125^\circ C$			0.8		
ENABLE Input Current	$I_{IH}$		$\overline{ENABLE} = 5V$		12	30	$\mu A$	
			$\overline{ENABLE} = 0V$		0	10		

- Note 1: External components such as the catch diode, inductor, input and output capacitors can affect switching regulator system performance. Refer to Application Information for details.
- Note 2: The oscillator frequency reduces to approximately 11kHz in the event of fault conditions, such as output short or overload. And the regulated output voltage will drop approximately 40% from the nominal output voltage. This self-protection feature lowers the average power dissipation by lowering the minimum duty cycle from 5% down to approximately 2%.
- Note 3: For these parameters, FB is removed from  $V_{OUT}$  and connected to +12V to force the output transistor OFF.
- Note 4:  $V_{OUT}$  pin sourcing current. No diode, inductor or capacitor connect to VOUT.
- Note 5: FB is removed from  $V_{OUT}$  and connected to 0V.

**CHARACTERIZATION CURVES**

Test circuits of Figure 1 and 2,  $T_A=25^\circ\text{C}$ , unless otherwise specified.

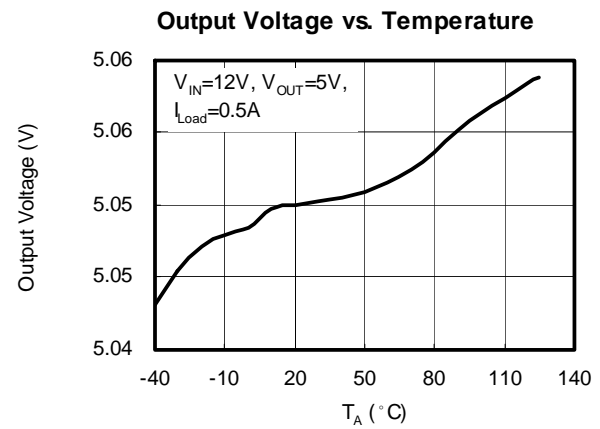
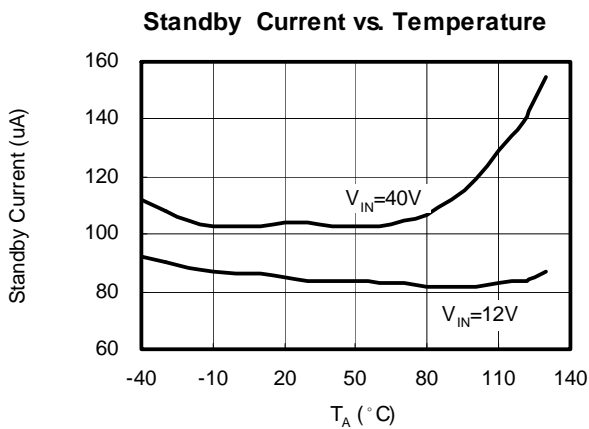
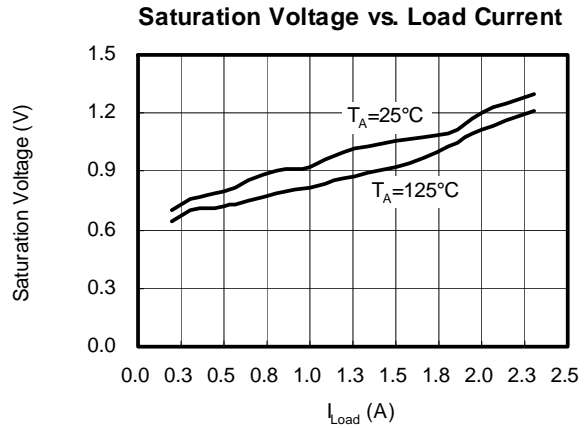
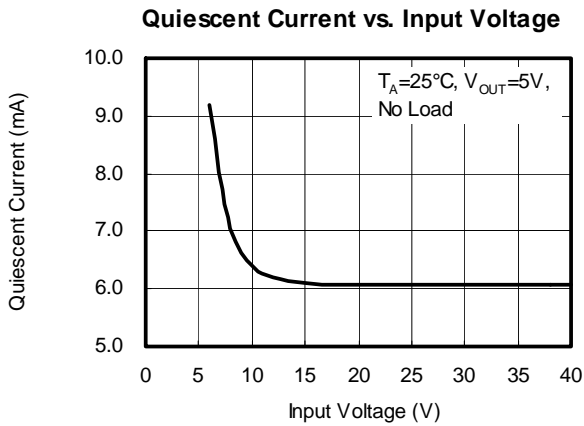
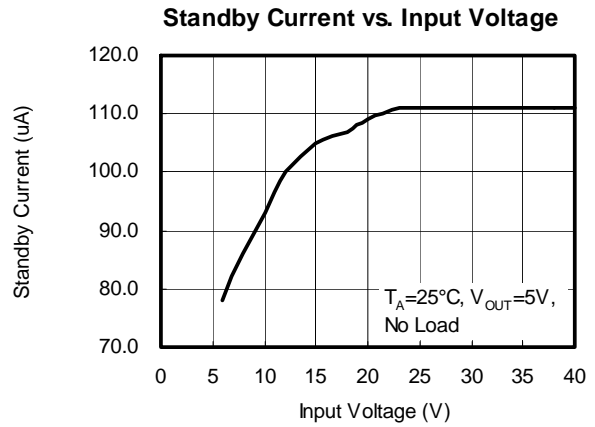
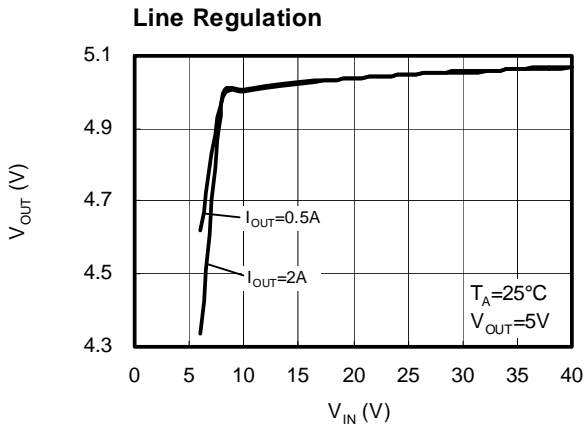

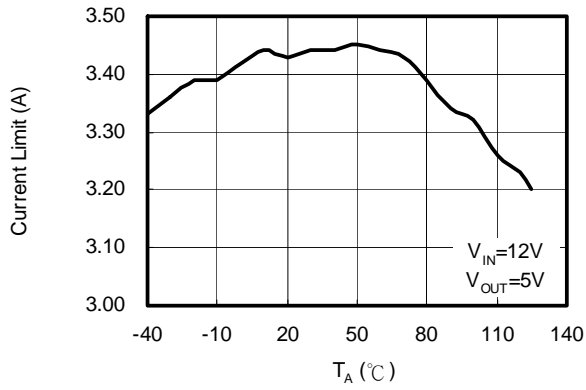
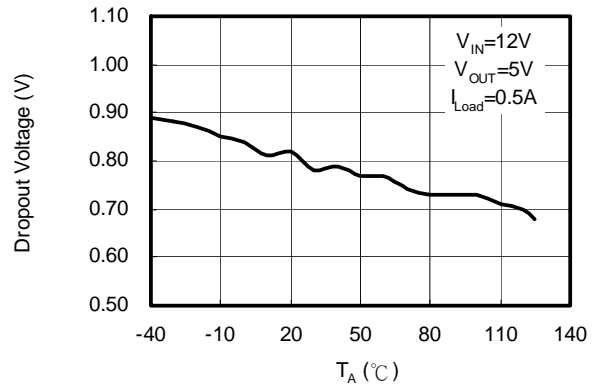
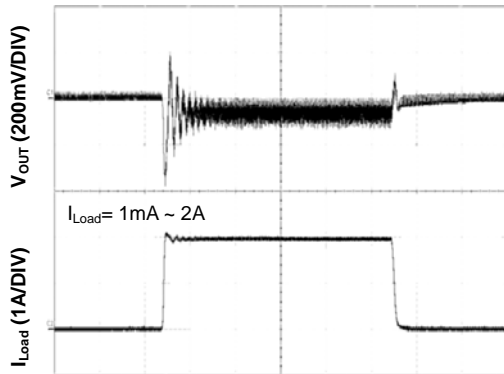
**Current Limit vs. Temperature**

**Dropout Voltage vs. Temperature**

**Load Transient Response**
 $V_{IN}=12V, C_{IN}=680\mu F, C_{OUT}=470\mu F, V_{OUT}=5V$ 

**TIME= 200 us/DIV**

---

**APPLICATION INFORMATION**

---

**Input Capacitors ( $C_{IN}$ )**

It is required that  $V_{IN}$  must be bypassed with at least a 100 $\mu$ F electrolytic capacitor for stability. Also, it is strongly recommended the capacitor's leads must be short, and located as near the regulator as possible. Too far away the  $C_{IN}$  may cause A307 unstable or damaged.

For low operating temperature range, for example, below -25°C, the input capacitor value may need to be larger. This is due to the reason that the capacitance value of electrolytic capacitors decreases and the ESR increases with lower temperatures and age. Paralleling a ceramic or solid tantalum capacitor will increase the regulator stability at cold temperatures.

**Output Capacitors ( $C_{OUT}$ )**

An output capacitor is also required to filter the output voltage and is needed for loop stability. The capacitor should be located near the A307 using short PC board traces. Low ESR types capacitors are recommended for low output ripple voltage and good stability. Generally, low value or low voltage (less than 12V) electrolytic capacitors usually have higher ESR values. For example, the lower capacitor values (220 $\mu$ F–1000 $\mu$ F) will yield typically 50 mV to 150 mV of output ripple voltage, while larger-value capacitors will reduce the ripple to approximately 20mV to 50mV with good chock and PCB layout.

The amount of output ripple voltage is primarily a function of the ESR (Equivalent Series Resistance) of the output capacitor and the amplitude of the inductor ripple current ( $\Delta I_{IND}$ ).

$$\text{Output Ripple Voltage} = (\Delta I_{IND}) \times (\text{ESR of } C_{OUT})$$

Some capacitors called “high-frequency,” “low-inductance,” or “low-ESR.” are recommended to use to further reduce the output ripple voltage to 10 mV or 20 mV. However, very low ESR capacitors, such as Tantalum capacitors, should be carefully evaluated.

**Catch Diode**

This diode is required to provide a return path for the inductor current when the switch is off. It should be located close to the A307 using short leads and short printed circuit traces as possible.

To satisfy the need of fast switching speed and low forward voltage drop, Schottky diodes are widely used to provide the best efficiency, especially in low output voltage switching regulators (less than 5V). Besides, fast-Recovery, high-efficiency, or ultra-fast recovery diodes are also suitable. But some types with an abrupt turn-off characteristic may cause instability and EMI problems. A fast-recovery diode with soft recovery characteristics is a better choice. Don't use those low speed diodes, 50/60Hz rectify use, for A307.

**Output Voltage Ripple and High Frequency Noise**

The output ripple voltage is due mainly to the inductor saw tooth ripple current multiplied by the ESR of the output capacitor.

The output voltage of a switching power supply will contain a saw tooth ripple voltage at the switcher frequency, typically about 1% of the output voltage, and may also contain high frequency voltage noise at the peaks of the saw tooth waveform.



Due to the fast switching action, and the parasitic inductance of the output filter capacitor, there is voltage spikes presenting at the peaks of the saw tooth waveform. Cautions must be taken for stray capacitance, wiring inductance, and even the scope probes used for transients evaluation. To minimize these voltage spikes, shortening the lead length and PCB traces is always the first thought. Further more, an additional small LC filter, ex:  $3\mu\text{H}$  &  $180\mu\text{F}$ , (as shown in Figure 4) will possibly provide a 10X reduction in output ripple voltage and transients.

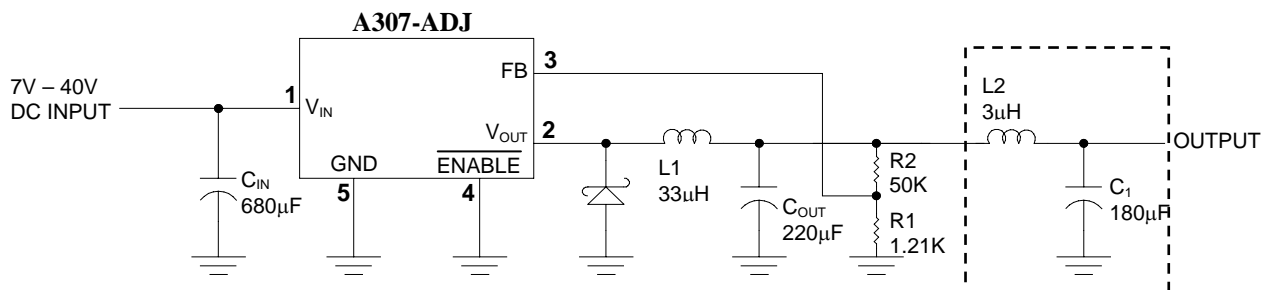

**Figure 4. LC Filter for Low Output Ripple**

### Inductor Selection

The A307 can be used for either continuous or discontinuous modes of operation. Each mode has distinctively different operating characteristics, which can affect the regulator performance and requirements.

With relatively heavy load currents, the circuit operates in the continuous current mode (inductor current always  $>0$ ), but under light load conditions, the circuit will be forced to the discontinuous mode (inductor current falls to zero for a period of time). For light loads (less than approximately 100 mA) it may be desirable to operate the regulator in the discontinuous mode, primarily because of the lower inductor values required for the discontinuous mode.

Inductors are available in different styles such as pot core, toroid, E-frame, rod core, et., as well as different core materials, such as ferrites and powdered iron. The least expensive, the rod core type, consists of wire wrapped on a ferrite rod core. This type of construction makes for an inexpensive inductor, but since the magnetic flux is not completely contained within the core, it generates more electromagnetic interference (EMI). This EMI can cause problems in sensitive circuits, or can give incorrect scope readings because of induced voltages in the scope probe.

An inductor should not be operated beyond its maximum rated current because it may saturate. When an inductor begins to saturate, the inductance decreases rapidly and the inductor begins to look mainly resistive (the DC resistance of the winding). This will cause the switch current to rise very rapidly. Different inductor types have different saturation characteristics, and this should be well considered when selecting an inductor.

### Feedback Connection

For fixed output voltage version, the FB (feedback) pin must be connected to  $V_{\text{OUT}}$ . For the adjustable version, it is important to place the output voltage ratio resistors near A307 as possible in order to minimize the noise introduction.

### ENABLE

It is required that the ENABLE **must not** be left open. For normal operation, connect this pin to a “LOW” voltage (typically, below 0.8V). On the other hand, for standby mode, connect this pin with a “HIGH” voltage. This pin can be safely pulled up to +V<sub>IN</sub> without a resistor in series with it.

### **Grounding**

To maintain output voltage stability, the power ground connections must be low-impedance. For the 5-lead TO-252 style package, both the tab and pin 3 are ground and either connection may be used. For SOP-EP-8 style package, both the thermal pad and pin 5 ~ 8 are ground and either connection may be used.

### **Heat Sink and Thermal Consideration**

Although the A307 requires only a small heat sink for most cases, the following thermal consideration is important for all operation. With the package thermal resistances  $\theta_{JA}$  and  $\theta_{JC}$ , total power dissipation can be estimated as follows:

$$P_D = (V_{IN} \times I_Q) + (V_{OUT} / V_{IN})(I_{LOAD} \times V_{SAT});$$

When no heat sink is used, the junction temperature rise can be determined by the following:

$$\Delta T_J = P_D \times \theta_{JA};$$

With the ambient temperature, the actual junction temperature will be:

$$T_J = \Delta T_J + T_A;$$

If the actual operating junction temperature is out of the safe operating junction temperature (typically 125°C), then a heat sink is required. When using a heat sink, the junction temperature rise will be reduced by the following:

$$\Delta T_J = P_D \times (\theta_{JC} + \theta_{CS} + \theta_{SA});$$

As one can see from the above, it is important to choose a heat sink with adequate size and thermal resistance, such that to maintain the regulator's junction temperature below the maximum operating temperature.

Note that, for SOP-EP-8 package type, the actual  $\theta_{JA}$  ( $= \theta_{JC} + \theta_{CS} + \theta_{SA}$ ) highly depends on the ground pad size that A307 is attached. Other factors, like the thickness of the copper foil, whether other heat-generating components (chock, Schottky diode, ... etc.) are close to chip, can highly increase the  $\theta_{JA}$ . Therefore, it is strongly recommended to maximize the ground pad size of A307 when designing the PCB, and double check the thermal performance when the PCB is ready.

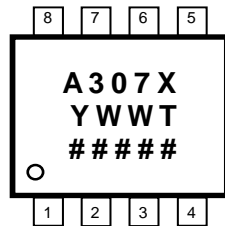
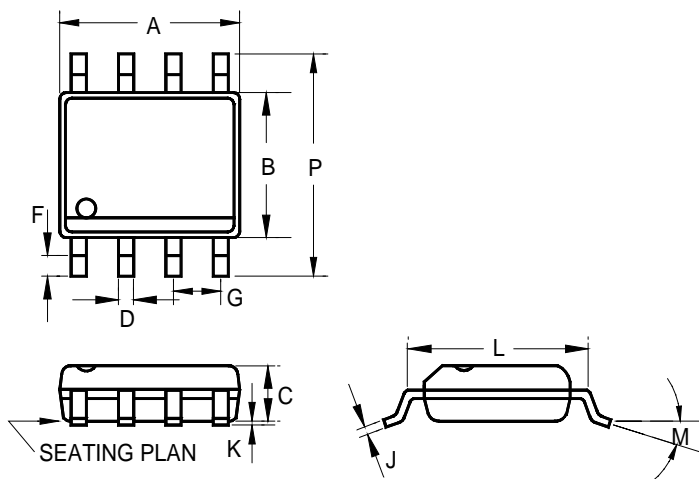
**PACKAGE**
**Top Marking For SOP 8-Pin**

**X: Voltage Options**
**A: ADJ Type**
**1: Fixed 3.3V Output**
**6: Fixed 5V Output**
**Y : Year Code**
**WW : Week Code**
**T : Trace Code**
**#### : Lot Number**
**SOP 8-Pin**

	INCHES			MILLIMETERS		
	MIN	TYP	MAX	MIN	TYP	MAX
A	0.183	-	0.202	4.65	-	5.13
B	0.144	0.156	0.163	3.66	3.95	4.14
C	0.068	-	0.074	1.35	-	1.88
D	0.010	0.016	0.020	0.25	0.41	0.51
F	0.015	0.020	0.035	0.38	0.50	0.89
G	0.050 BSC			1.27 BSC		
J	0.007	-	0.010	0.19	-	0.25
K	0.005	-	0.010	0.13	-	0.25
L	0.189	-	0.205	4.80	-	5.21
M	0°	-	8°	0°	-	8°
P	0.228	0.236	0.244	5.79	6.00	6.20

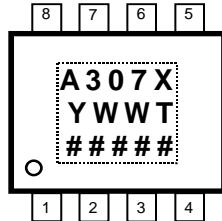
Top Marking For SOP-EP 8-Pin



X: Voltage Options  
 A: ADJ Type  
 1: Fixed 3.3V Output  
 6: Fixed 5V Output  
 Y : Year Code  
 WW : Week Code  
 T : Trace Code  
 ##### : Lot Number

SOP-EP 8-Pin

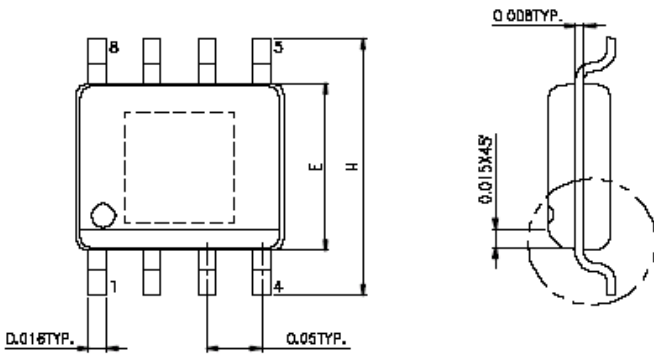

SYMBOLS	MIN.	MAX.
A	0.053	0.069
A1	0.002	0.006
A2	-	0.059
D	0.189	0.196
E	0.150	0.157
H	0.228	0.244
L	0.016	0.050
$\theta^\circ$	0	8

UNIT: INCH

THERMALLY ENHANCED DIMENSIONS

PAD SIZE	E1	D1
90X90E	0.081 REF	0.081 REF
95X13E	0.086 REF	0.117 REF

UNIT: INCH

NOTES:

1. JEDEC OUTLINE: N/A
2. DIMENSIONS "D" DOES NOT INCLUDE MOLD FLASH, PROTRUSIONS OR GATE BURRS. MOLD FLASH, PROTRUSIONS AND GATE BURRS SHALL NOT EXCEED 15mm (.005in) PER SIDE.
3. DIMENSIONS "E" DOES NOT INCLUDE INTER-LEAD FLASH, OR PROTRUSIONS. INTER-LEAD FLASH AND PROTRUSIONS SHALL NOT EXCEED .25mm (.010in) PER SIDE.

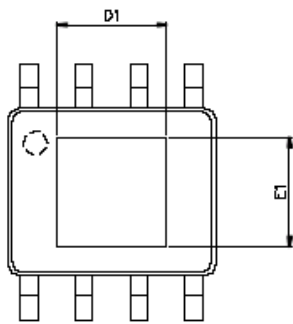

E.P. VERSION ONLY

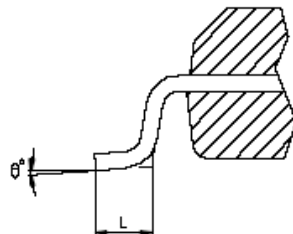

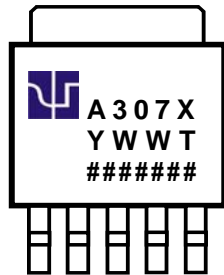
**Top Marking For TO-252 5-Pin**

**X: Voltage Options**  
**A: ADJ Type**  
**1: Fixed 3.3V Output**  
**6: Fixed 5V Output**  
**Y : Year Code**  
**WW : Week Code**  
**T : Trace Code**  
**##### : Lot Number**

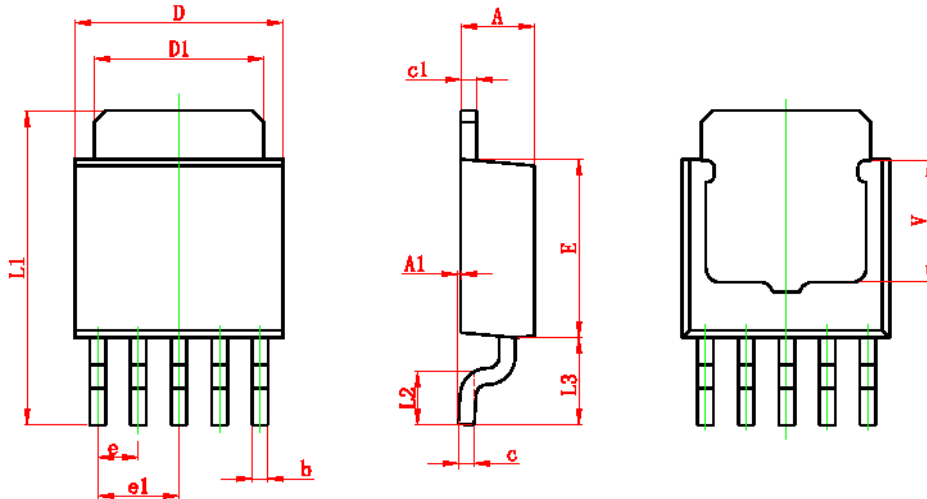
**TO-252-5L**

Symbol	Dimensions in Millimeters		Dimensions in Inches	
	MIN	MAX	MIN	MAX
A	2.200	2.400	0.087	0.094
A1	0.000	0.127	0.000	0.005
B	0.400	0.600	0.016	0.024
C	0.430	0.580	0.017	0.023
c1	0.430	0.580	0.017	0.023
D	6.350	6.650	0.250	0.262
D1	5.200	5.400	0.205	0.213
E	5.400	5.700	0.213	0.224
E	1.270 TYP		0.050 TYP	
e1	2.540 TYP		1.000 TYP	
L1	9.500	9.900	0.374	0.390
L2	1.400	1.780	0.055	0.070
L3	2.550	2.900	0.100	0.114
V	3.800 REF		0.150 REF	

**IMPORTANT NOTICE**

ADDtek reserves the right to make changes to its products or to discontinue any integrated circuit product or service without notice, and advises its customers to obtain the latest version of relevant information to verify, before placing orders, that the information being relied on is current.

A few applications using integrated circuit products may involve potential risks of death, personal injury, or severe property or environmental damage. ADDtek integrated circuit products are not designed, intended, authorized, or warranted to be suitable for use in life-support applications, devices or systems or other critical applications. Use of ADDtek products in such applications is understood to be fully at the risk of the customer. In order to minimize risks associated with the customer's applications, the customer should provide adequate design and operating safeguards.

ADDtek assumes no liability to customer product design or application support. ADDtek warrants the performance of its products to the specifications applicable at the time of sale.

---

**ADDtek Corp.**  
9F, No. 20, Sec. 3, Bade Rd., Taipei, Taiwan, 105  
TEL: 2-25700299  
FAX: 2-25700196

---