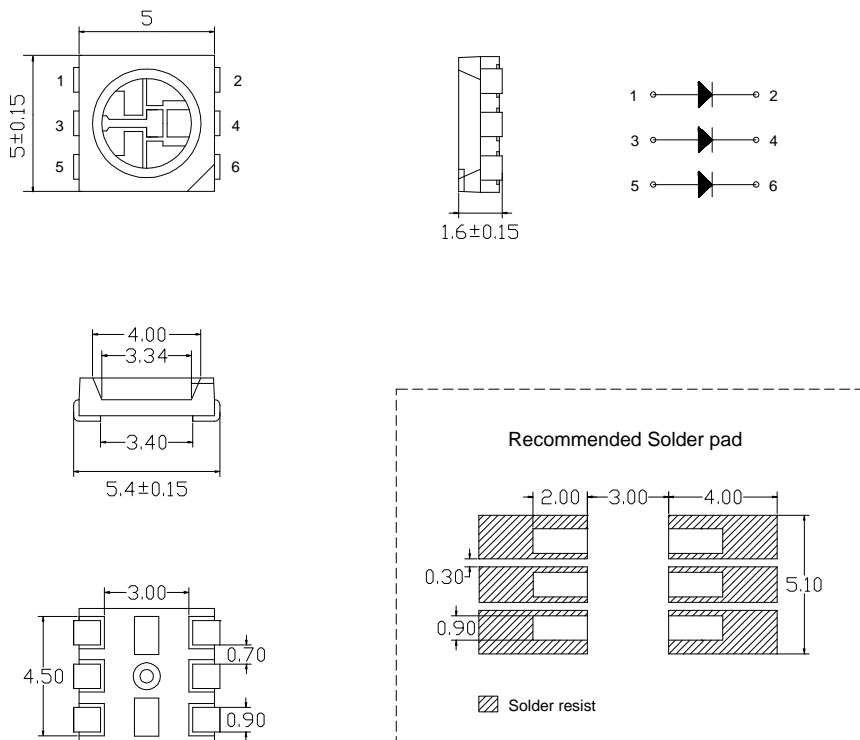

White TOP LED (5050)

Lead(Pb) Free Product-ROHS Compliant

■ Applications

1. Interior automotive lighting(dashboard backlight etc...)
2. Optical indicators
3. Communication Products
4. Backlighting
5. Flash
6. Toys

■ Package Dimensions



Notes:

All dimensions in mm tolerance is ± 0.1 mm unless otherwise noted.

■ Absolute Maximum Ratings (Ta = 25°C)

Items	Symbol	Absolute maximum Rating	Unit
Power Dissipation	P _D	3*100	mW
Forward Current(DC)	I _F	3*25	mA
Peak Forward Current**	I _{FP}	3*100	mA
Operation Temperature	T _{opr}	-40~ +85	°C
Storage Temperature	T _{stg}	-40 ~ +100	°C

**Pulse width ≤ 0.1msec duty ≤ 1/10

■ Typical Electrical & Optical Characteristics (Ta = 25°C)

Items	Symbol	Condition	Min.	Typ.	Max.	Unit
Forward Voltage	V _F	I _F = 3*20mA	2.8	3.2		V
Reverse Current	I _R	V _R = 5V	---	---	10	μ A
Chromatic Coordinates**	CCT	I _F = 3*20mA	6000	6500	7000	K
Luminous Intensity**	I _V	I _F = 3*20mA	5900	6500	---	mcd
Luminous flux**	Flux	I _F = 60mA	'---	14	'---	lm
50% Power Angle**	2 θ ½	I _F = 3*20mA	---	120	---	Deg

** Luminous intensity , Luminous flux ,CIE and View angle data are the Values when 3 circuits are lit simultaneously.

■ Ranks Combination (IF = 60mA)

Rank	V2	W1
Luminous Intensity(mcd)	4188-5235	5235-6543

■ Notes

1. Tolerance of measurement of luminous intensity : ±15%
2. Tolerance of measurement of chromatic coordinates : ±0.02
3. Tolerance of measurement of forward voltage : ±0.1V

■ Chromatic Coordinates Ranks

	S11		S12		S13		S14		S15	
X	0.2958	0.3000	0.3000	0.3043	0.3043	0.3085	0.3085	0.3127	0.3127	0.3170
Y	0.3396	0.3443	0.3443	0.3490	0.3490	0.3537	0.3537	0.3584	0.3584	0.3632
X	0.3032	0.3073	0.3073	0.3115	0.3115	0.3157	0.3157	0.3199	0.3199	0.3242
Y	0.3365	0.3412	0.3412	0.3459	0.3459	0.3506	0.3506	0.3553	0.3553	0.3602
	S21		S22		S23		S24		S25	
X	0.2988	0.3032	0.3032	0.3073	0.3073	0.3115	0.3115	0.3157	0.3157	0.3199
Y	0.3307	0.3365	0.3365	0.3412	0.3412	0.3459	0.3459	0.3506	0.3506	0.3553
X	0.3059	0.3104	0.3104	0.3146	0.3146	0.3188	0.3188	0.3230	0.3230	0.3273
Y	0.3276	0.3334	0.3334	0.3380	0.3380	0.3428	0.3428	0.3475	0.3475	0.3522
	S31		S32		S33		S34			
X	0.3016	0.3059	0.3059	0.3104	0.3104	0.3146	0.3146	0.3188		
Y	0.3219	0.3276	0.3276	0.3334	0.3334	0.3380	0.3380	0.3428		
X	0.3091	0.3134	0.3134	0.3178	0.3178	0.3220	0.3220	0.3262		
Y	0.3186	0.3244	0.3244	0.3301	0.3301	0.3349	0.3349	0.3396		
	S41		S42		S43		S44			
X	0.3047	0.3091	0.3091	0.3134	0.3134	0.3178	0.3178	0.3220		
Y	0.3129	0.3186	0.3186	0.3244	0.3244	0.3301	0.3301	0.3349		
X	0.3117	0.3161	0.3161	0.3204	0.3204	0.3248	0.3248	0.3290		
Y	0.3099	0.3156	0.3156	0.3214	0.3214	0.3271	0.3271	0.3318		
	S51		S52		S53					
X	0.3074	0.3117	0.3117	0.3161	0.3161	0.3204				
Y	0.3041	0.3099	0.3099	0.3156	0.3156	0.3214				
X	0.3147	0.3090	0.3190	0.3234	0.3234	0.3277				
Y	0.3010	0.3067	0.3067	0.3125	0.3125	0.3182				

■ Typical Electrical/ Optical Characteristics Curves (Ta=25°C Unless Otherwise Noted)

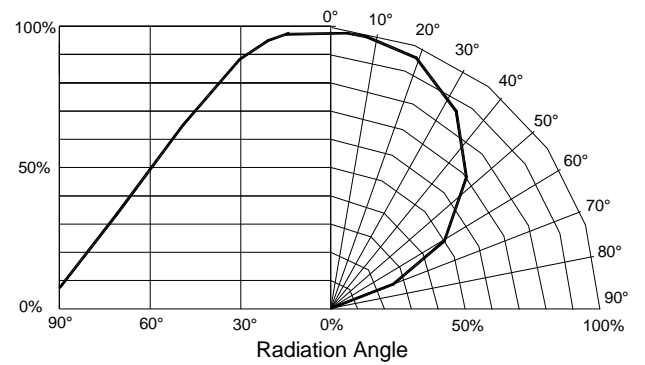
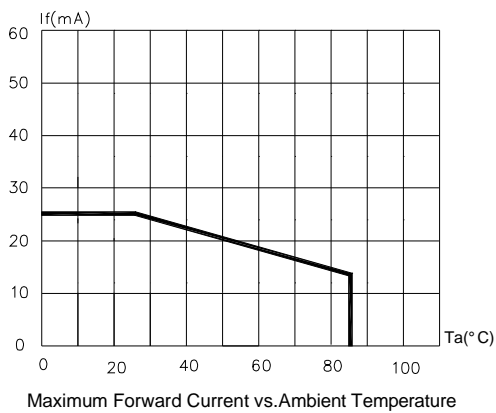
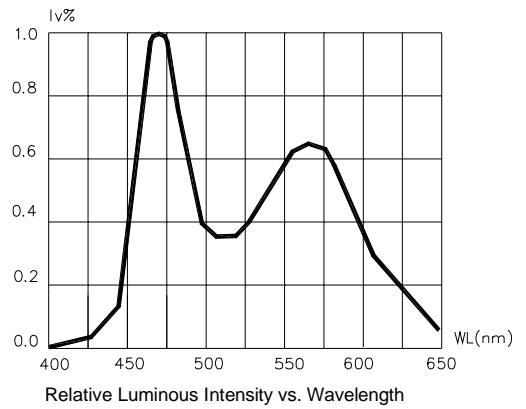
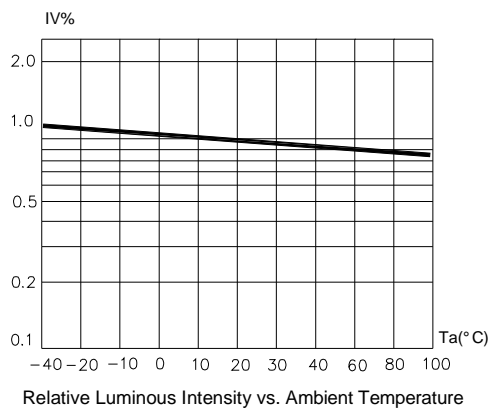
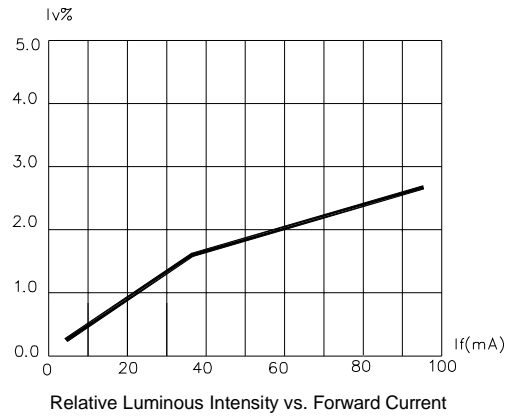
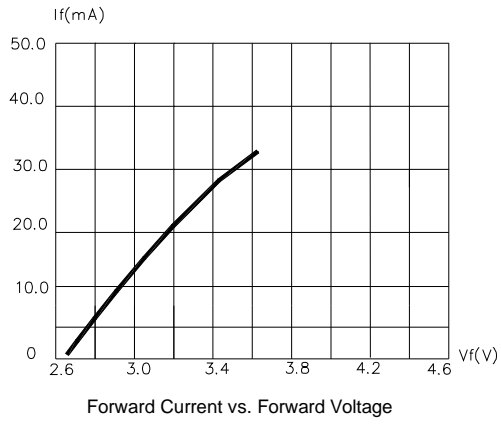

■ Soldering heat reliability:
Lead Solder

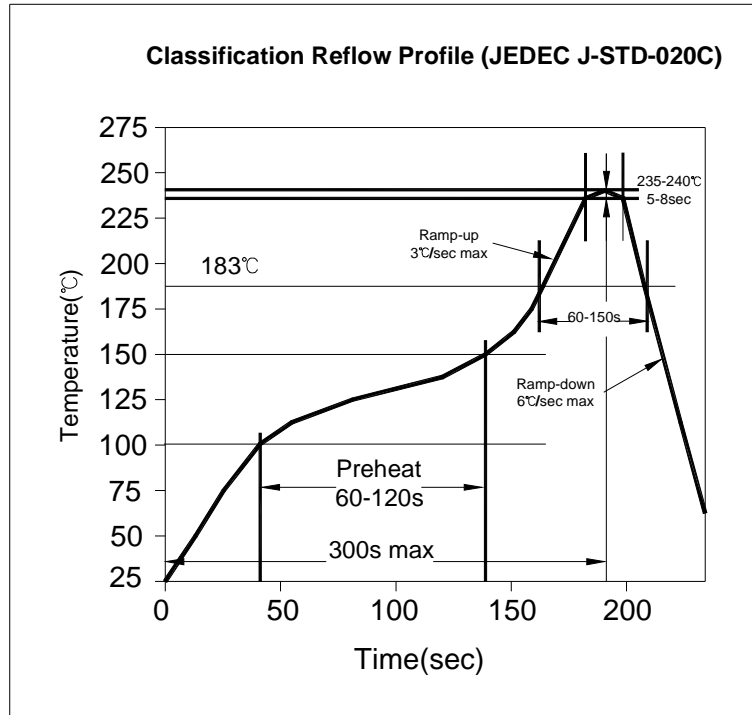

Lead Free Solder

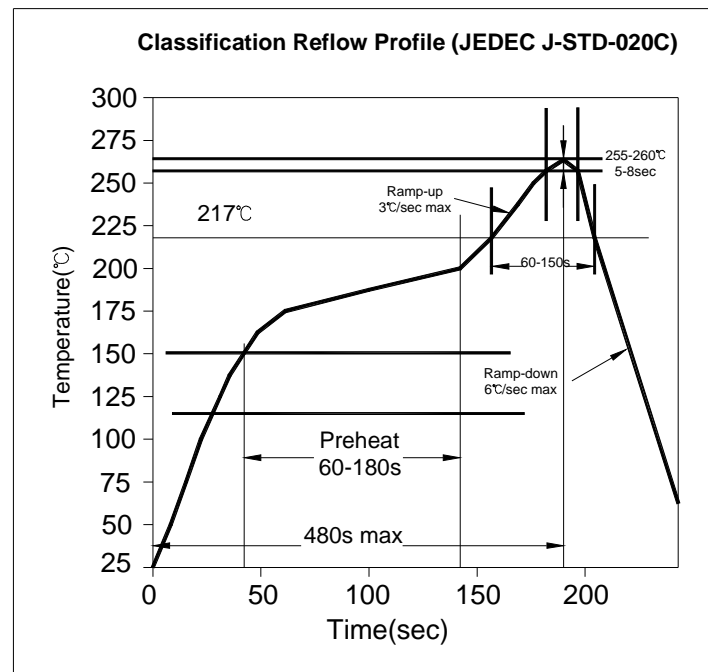

■ Packing Specifications:

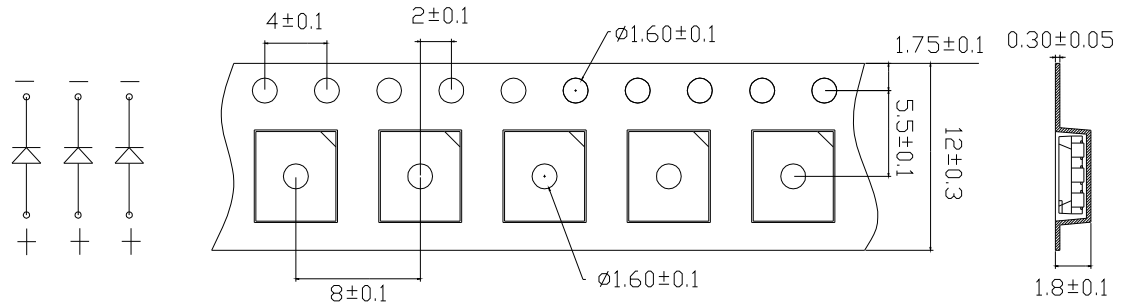

■ Reel Specifications

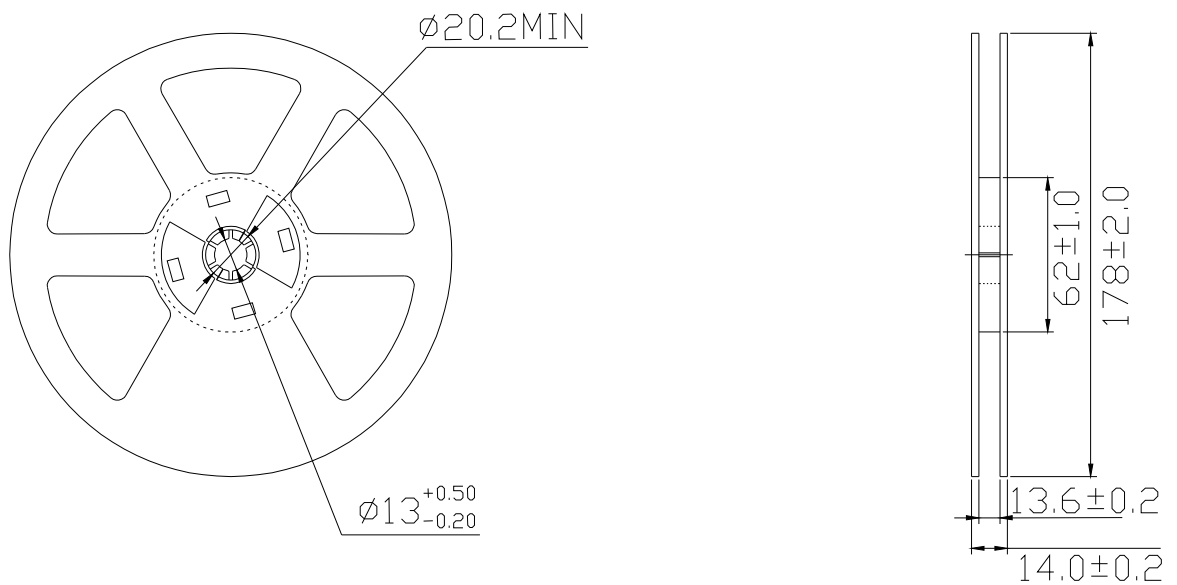

Dimensions are specified as follows: mm

Notes: Normal packing quantity: 1,000 pcs/reel

■ Handling Precautions

Compare to epoxy encapsulant that is hard and brittle, silicone is softer and flexible. Although its characteristic significantly reduces thermal stress, it is more susceptible to damage by external mechanical force.

As a result, special handling precautions need to be observed during assembly using silicone encapsulated LED products. Failure to comply might leads to damage and premature failure of the LED.

1. Handle the component along the side surfaces by using forceps or appropriate tools.

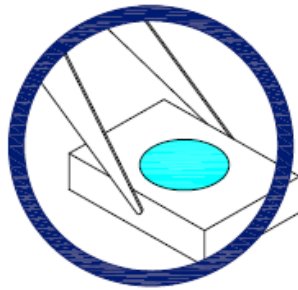

2. Do not directly touch or handle the silicone lens surface. It may damage the internal circuitry.

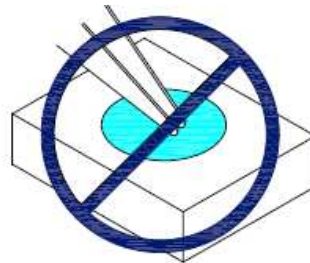

3. Do not stack together assembled PCBs containing exposed LEDs. Outside impact may scratch the silicone lens or damage the internal circuitry.

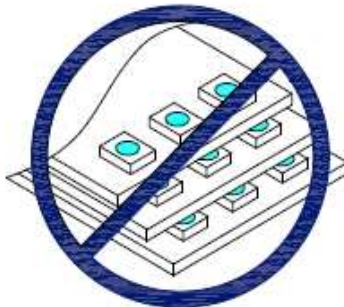

4. The outer diameter of the TOP LED pickup nozzle should not exceed the size of the LED to prevent air leaks. The inner diameter of the nozzle should be as large as

possible.

5. A pliable material is suggested for the nozzle tip to avoid scratching or damaging the LED surface during pickup.
6. The dimensions of the component must be accurately programmed in the pick-and-place machine to insure precise pickup and avoid damage during production.

